

Overvoltage Problems of Small-Scale Generators Connected to Large Systems

João R. Cogo, Hermann W. Dommel

Abstract—Electric utility companies and/or government agencies, as well as professional organizations such as IEEE, are formulating interconnection requirements for connecting small distributed or dispersed-resource generation to large utility systems. “Small” typically implies generators up to 30 MW. If the small generator is connected to the distribution system, as is normally the case, then the distribution system will no longer be radial, which requires changes to the protection.

Some of the protection-related problems are inadequate coordination, energization with generators out of synchronism, transfer tripping, protection against formation of unintentional islands, overvoltages, etc.

This paper discusses transient studies made for the connection of an Independent Power Producer (IPP) to a 138 kV connection point. The results show the overvoltages that can result from out-of-step reclosing after a line-to-line fault with ground connection on the transmission line. Solutions are suggested to prevent sustained overvoltages with revised under- and overvoltage settings. The proper choice of surge arresters is discussed as well.

If the IPP is connected to a distribution system of 13.8 kV, 25 kV or 34.5 kV, the grounding of the neutral of the transformer at the connection point (point of common coupling) will influence the current distribution between the utility and IPP. This will affect the sensitivity of the neutral protection relays.

Keywords: Independent power producer (IPP); protection; sustained overvoltages; protection relays.

I. NOMENCLATURE

NIS - National Interconnected Transmission System

DIS - Distribution Interconnected System

ACCESSOR – One who wants to connect to NIS or DIS

IPP - Independent Power Producer

II. INTRODUCTION

De-regulation of the electric power industry, demands for increased efficiency of the transmission and distribution systems, and lobbying for environmentally friendly energy sources, has established a worldwide trend to allow network access to Independent Power Producers (IPP), to Power Auto Producers (AP), and to other users. Often, incentives are given to such decentralized generation of power.

This decentralized or distributed generation is characterized by small power sources (in Brazil up to 30MW), that are usually located close to loads, without necessity of central control. These power sources may be conventional systems such as small hydroelectric plants (SHPs), power co-generation plants, wind turbines, and other technologies.

Among its advantages are shorter implementation times compared to projects of centralized generation, deferment of reinforcements in the transmission grid, increased reliability of close-by consumers, better system stability, lower transmission losses, reduction of environmental impacts, and increased energy efficiency.

The current model for the Brazilian electric sector ensures free access of power producers to the electric power system. The last decade of the 20th century saw a large rise in the number of auto-producers, independent power producers, and co-generators.

Even though this creates economic and environmental benefits, this distributed generation also creates technical, legal and economic problems. Some such technical problems are studied in this paper.

In Brazil, the enactment of Law 8987 of Feb 13 1995 established the “Regime of Grant and Permission for Rendering of Public Services”, which guides the purchase and sale of electrical power. Based on this Law and on Rules from ANEEL (Agência Nacional de Energia Elétrica) for regulating the production, transmission, distribution and trade of electrical power services, ACCESSORS must meet certain conditions to use the National Interconnected System (NIS) or the Distribution Interconnected System (DIS).

Through Law 8987, small independent producers have been authorized to operate in parallel with NIS or DIS, as summarized in Table I.

One major problem concerns the connection of industrial systems to NIS or DIS, when the connection is made through delta-connected transformers on the high voltage side, as illustrated in Fig. 1.

In this paper, the effects of ground faults at the point of common coupling are studied, as shown in Fig. 2, which is part of the system of Fig. 1. The study involves a transformer (TF), a typical generator of an IPP, and the connection with the local utility (LU) through a 138 kV transmission line.

III. CHARACTERISTICS OF THE SYSTEM UNDER ANALYSIS

The basic data of the main equipment in the system under study is indicated next, as well as in Fig. 2.

J. R.. Cogo is with GSI- Engenharia e Consultoria Ltda., CEP 12.062-120, Taubaté, SP, Brazil (e-mail: gsi@gsiconsultoria.com.br).

H. W. Dommel is with The University of British Columbia, Vancouver, BC, V6T 1Z4, Canada (e-mail of corresponding author: hermannnd@ece.ubc.ca).

The local utility is represented as a Thevenin equivalent circuit, with a voltage source behind the zero- and positive-sequence short-circuit impedances that are converted to mutually coupled impedances in phase quantities (see Fig. 2).

TABLE I

INDEPENDENT PRODUCERS IN OPERATION AND INSTALLED CAPACITY

Type	No. of units	[MW]	%	
Hydro	633	73,558	70.50	
Gas	Natural	74	9,860	
	Process	27	939	
Petroleum	Diesel	546	3,053	
	Residual	20	1,408	
Biomass	Sugar cane	226	2,657	
	Black liquor	13	785	
	Wood	26	224	
	Bio gas	2	20	
	Rice	2	6	
Nuclear	2	2,007	1.92	
Mineral Coal	Mineral coal	7	1,415	1.36
Wind		15	237	0.23
Imports	Paraguay		5,650	5.46
	Argentina		2,250	2.17
	Venezuela		200	0.19
	Uruguay		70	0.07
Total			104,339	100

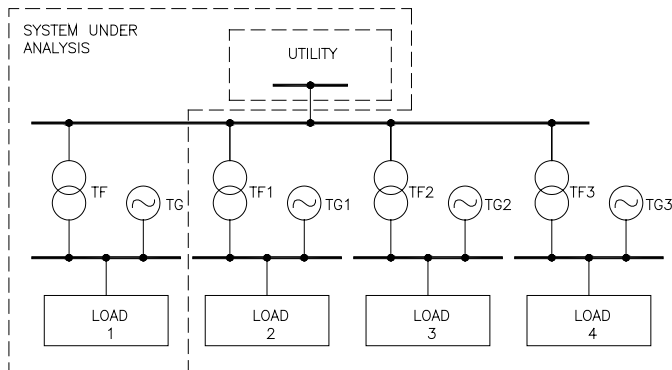

Fig. 1. Typical system of an independent power producer

The IPP is supplied through a typical 138 kV three-phase transmission line (LT) between FEL and IPP substations. The line has triangular conductor configuration (code Linnet), without ground wires. Its line parameters are shown in Fig. 2.

A. Electrical System on 13.8 kV Side

The characteristics of the equipment on the 13.8 kV side are as follows:

- Transformer TF

Power	20 MVA
Percent impedance	16.00 %
Primary rated voltage	138 kV
Secondary rated voltage	13.8 kV
Connection, 138 kV side	Delta
Connection, 13.8 kV side	Wye
Other data see Fig. 2	

- Synchronous Machine TG

Power factor	0.80
Inertia constant	2.37 s
Other data see Table II.	

- Cable 1

Gauge	240 mm ²
Length	600 m
Configuration	Flat, 3 single-phase cables
Rated voltage	15 kV (phase-to-phase)
Insulating material	EPR

The other cables indicated are less than 50 m long and are not considered.

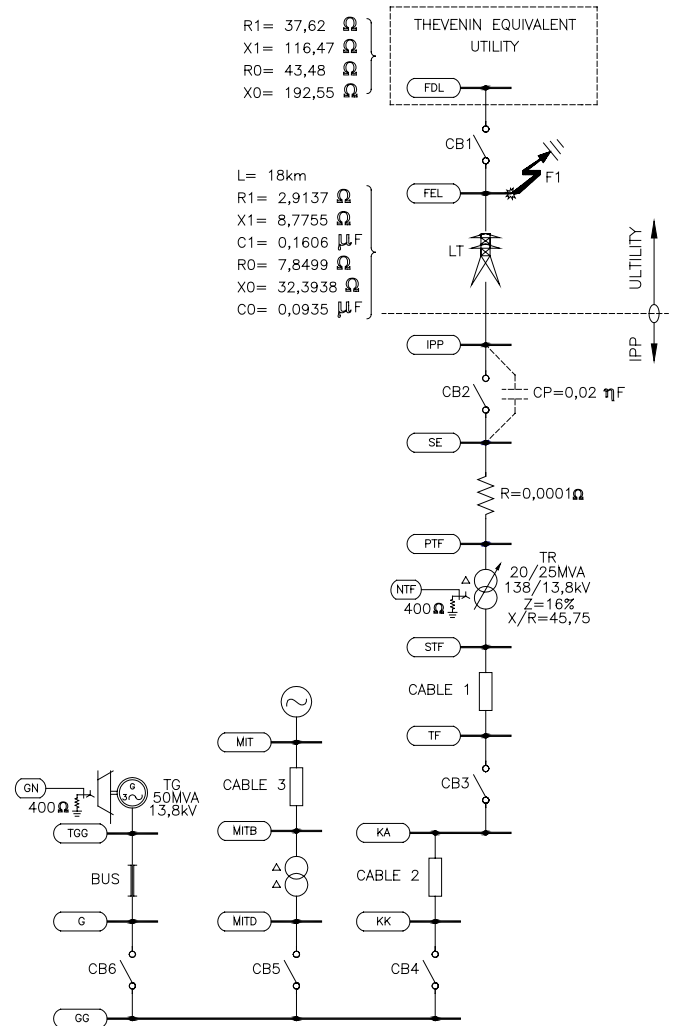

Fig. 2. System under analysis

TABLE II
SYNCHRONOUS GENERATOR DATA

	per unit		s
Ra	0.001723	T'd0	6.4990
Xl	0.1600	T'q0	2.5000
Xd	2.120	T''d0	0.0450
Xq	2.140	T''q0	0.1500
X'd	0.2560	T'd	0.7698
X'q	0.4570	T'q	0.4394
X''d	0.1620	T''d	0.0289
X''q	0.1780	T''q	0.0709
X0	0.1070		

- Circuit Breaker on 138 kV side

Rated current	3150 A
Rated voltage	242 kV
Short-circuit rated interruption	40 kA
First pole factor	1.5
Interruption in phase disagreement	10 kA
Interruption of capacitive currents	130 A
Rated interruption time	65 ms
Frequency	60 Hz
Chopping current	4 to 6 A

IV. CASES SIMULATED

Several cases have been analyzed for the Fig. 2 system. The main ones are discussed below.

A. Sustained Ground Fault on 138 kV side in SE busbar

For line-to-ground faults in phase A at busbar SE, there will be sustained overvoltages until the protection scheme eliminates them. In summary, the protection scheme operates as follows:

- opening of CB1 by instantaneous overcurrent protection;
- opening of CB2 by backup overvoltage protection, within 2.3 s.

As long as the fault lasts, the line-to-ground fault overvoltage (peak value) is of the order of 303.56 kV (see SEC in Fig. 3, for bus SE, phase C). In addition, a variation in the generator voltage of the order of 5% must be considered and, therefore, the final value of the sustained overvoltage (peak value) will be of the order of 315 kV from phase to ground.

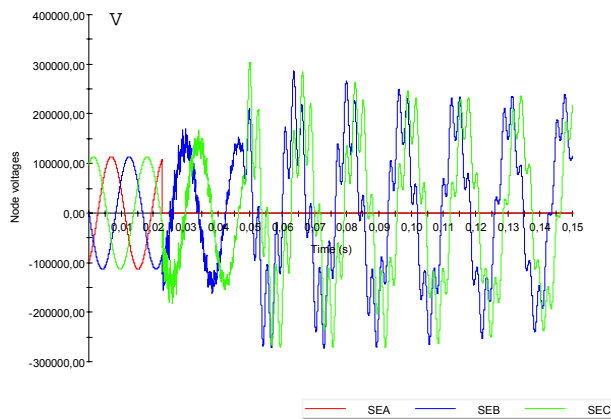

Fig. 3. Sustained overvoltage during ground fault in phase A, 138 kV busbar SE

In Fig. 3 the fault starts at $t=22.778$ ms. If the fault were to start at $t=23.556$ ms, the overvoltage would be 280.541 kV. This shows that the instant of fault initiation influences the obtained results.

The overvoltages presented in Fig. 3 were simulated without considering the effects of surge arresters. For a more detailed analysis, two types of surge arresters were

considered. One type was used for Fig. 4 and another type for Fig. 5.

For Fig. 4, the characteristics of the surge arresters were:

Frequency	60 Hz
Type: Metal-oxide without spark gaps	
Rated voltage	144 kV
Continuous operating voltage	115 kV
Discharge current 8/20 μ s	10 kA
Power absorption	8.0 kJ/kV (continuous operating voltage phase to ground in RMS)
Class according to IEC	60099-4 3
Residual voltages:	

0.5 kA	282 kV crest
1.0 kA	293 kV crest
2.0 kA	307 kV crest
5.0 kA	332 kV crest
10.0 kA	353 kV crest
20.0 kA	395 kV crest
40.0 kA	447 kV crest

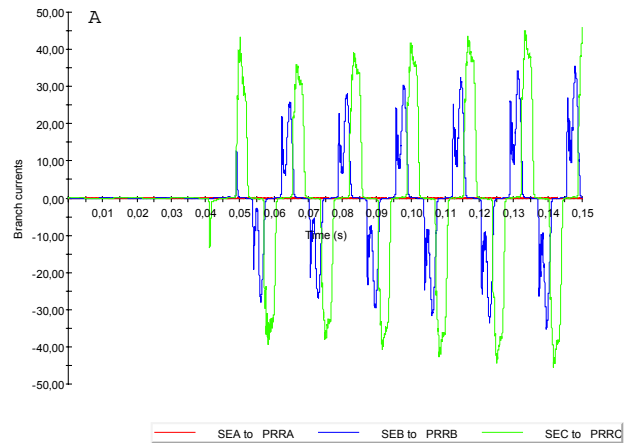

Fig. 4. Wave shapes for the sustained currents in the surge arresters with rated voltage of 144 kV during ground fault in phase A, 138 kV busbar SE (fault starting at $t = 22.778$ ms)

For Fig. 5, the characteristics of the surge arresters were the same as before, except:

Rated voltage	183 kV
Continuous operating voltage	146 kV
Residual voltages:	

0.5 kA	351 kV crest
1.0 kA	360 kV crest
2.0 kA	378 kV crest
5.0 kA	413 kV crest
10.0 kA	439 kV crest
20.0 kA	488 kV crest
40.0 kA	553 kV crest

By comparing Figs. 4 and 5, one can see that the current is higher in the surge arresters rated 144 kV, which are classically used in this kind of application for handling sustained faults.

B. Opening of the TF Transformer Circuit Breaker

Disconnecting the Independent Power Producer from the

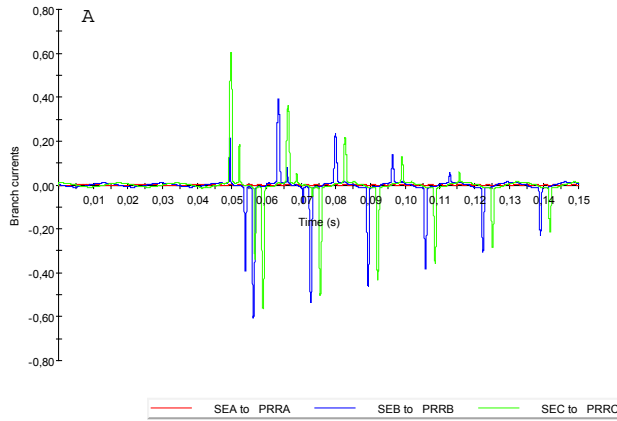

Fig. 5. Wave shape for the sustained currents in the surge arresters with rated voltage of 183 kV during ground fault in phase A, 138 kV busbar SE (fault starting at $t = 22.778$ ms)

Utility can create problems for the operation of the circuit breaker, because it must support a very high voltage between its contacts after the arc is extinguished. To simulate this opening operation on the 138 kV side, a parasitic capacitance of 20 nF was added between the CB2 breaker poles. The following operation sequence was considered:

- Occurrence of a ground fault at the end of the transmission line (point F1, busbar FEL);
- Opening of the CB1 circuit breaker at the end of the line (the fault was still on at the end of the transmission line);
- Opening of the CB2 circuit breaker on the TF transformer primary side.

Since the TF transformer on the 138 kV side is delta connected, the occurrence of a ground fault in busbar FEL after opening of CB1 causes high overvoltages in the CB2 terminals during opening.

Two cases were analyzed:

- Case 1: with the simultaneous opening of the breaker poles, an overvoltage of 274.64 kV was obtained (between the poles when totally open), as can be seen in the first higher peak (line B) in Fig. 6.
- Case 2: by considering a dispersion of 3 ms between opening of the breaker poles, an overvoltage of 416.46 kV was obtained (between the poles when totally open), as shown in Figs. 7 and 8.

To best view the overvoltages in the last case, Fig. 7 is expanded to Fig. 8.

Figs. 6, 7 and 8 consider the fault clearing by circuit breaker CB1, with the three phases simultaneously opening at 40 ms (current interruption after the first current zero).

These values are already extremely high for this voltage class, but they are not the final answer, because there may be other combinations of values that were not covered. A reasonable sampling of all combinations may require 100 runs or so, considering:

- The minimum, average, and maximum dispersion

- values for opening of the breaker poles;
- The parasitic capacitances between the breaker poles when totally open;
- The parasitic capacitances of the breaker bushings between line and ground.

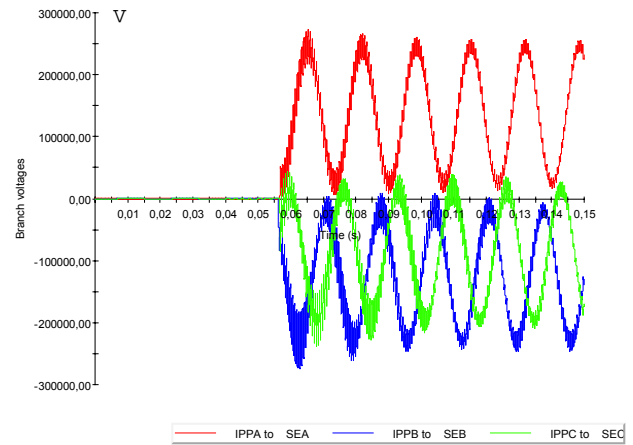

Fig. 6. Potential difference between the poles after opening circuit breaker CB2 for ground fault in busbar FEL, without dispersion of poles and opening of the three phases at 55.778 ms (current interruption after first current zero)

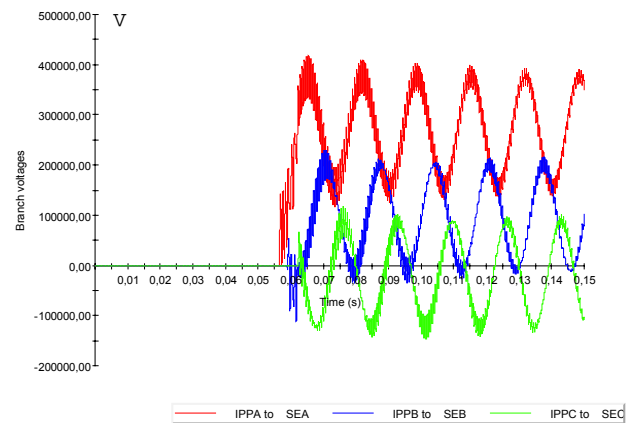

Fig. 7. Potential difference between the poles after opening of circuit breaker CB2 for ground fault in busbar FEL with dispersion of the poles and opening at 55.778, 58.778 and 61.778 ms (current interruption after first current zero)

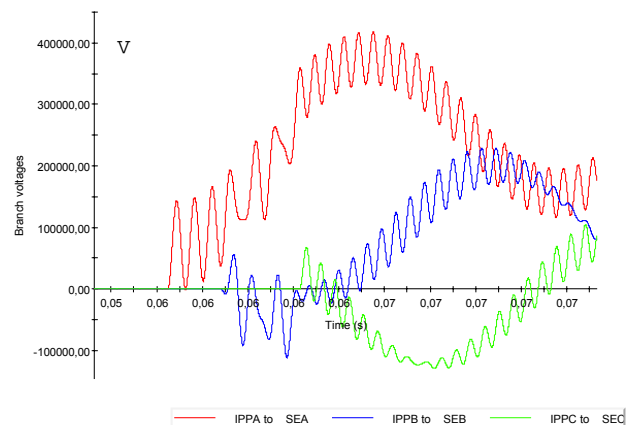

Fig. 8 Potential difference between the poles after opening of circuit breaker CB2 for ground fault in busbar FEL (expansion of Fig. 7)

V. CONCLUSIONS

- According to Figs. 4 and 5, the sustained overvoltages directly affect the choice of the arresters. In the system under analysis, with an operating voltage of 138 kV, it is still common practice to use arresters with a rated voltage of 144 kV. This rating seems to be unsuitable. It has occasionally caused explosions, as observed in some plants that use such devices. For such a system it is better to use arresters with a voltage class above 144 kV, namely at 183 kV. This becomes clear when comparing the currents through the arresters, which were in the order of 50 A (see Fig. 4), but only 0.7 A with the higher rating (see Fig. 5).
- The 138 kV circuit breakers must have enough capacity to interrupt small capacitive currents when the transmission lines are operating at no-load. In the case under analysis, this current is of the order of 5 A (RMS). No overvoltages originating from the interruptions of small capacitive and inductive currents, with chopping under 4 A, have been identified that might damage the circuit breaker when in normal operation.
- During a ground fault in busbar FEL, circuit breaker CB1 starts the process of simultaneous interruption of the fault currents in 40 ms. But since the arc is only extinguished when the fault current reaches its next zero, CB1 will interrupt the ground currents at the following instants:

current in phase C: $t = 40.35$ ms

current in phase A: $t = 47.89$ ms

current in phase B: $t = 48.19$ ms.

Therefore, when CB1 starts its interruption process, the current magnitudes are very small, because transformer TF is delta connected on the 138 kV side. Its value is of the same order as that in steady state, as shown in Fig. 9. Since the potential difference between the poles, after opening of CB2, is very high (416 kV), there will be an arc of long duration, which compromises the useful life of the breaker contacts under these operating conditions.

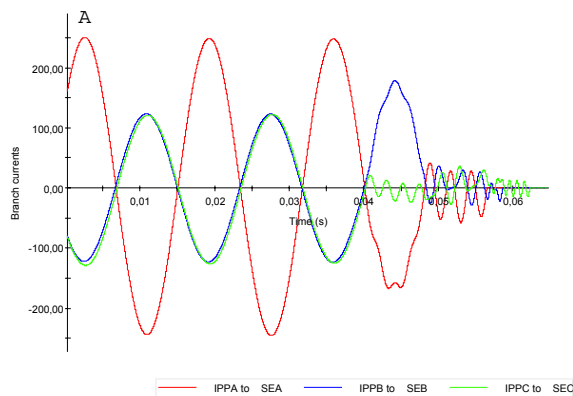

Fig. 9 Wave shape of the current wave during opening of circuit breaker CB2 during sustained ground fault in phase A in busbar FEL (opening at 55.778, 58.778 and 61.778 ms after first current zero)

VI. REFERENCES

- [1] Microtran - *Transients Analysis Program for Personal Computers*. Microtran Power System Analysis Corporation, Vancouver, Canada.
- [2] H. W. Dommel, *EMTP Theory Book*, 2nd ed. Microtran Power System Analysis Corporation, Vancouver, Canada, May 1992.
- [3] Norma Brasileira de Referência (NBR) 5422; Associação Brasileira de Normas Técnicas (ABNT) – Electrical Power Transmission Overhead Line Projects – Procedures, February 1985 and revision of June 1996 (in Portuguese).
- [4] J. A. Martinez-Velasco, *Computer Analysis of Electric Power System Transients*. IEEE, New Jersey, 1997.
- [5] ANEEL. Matrix of Electrical Power. Web site visited Jan-03-07: <http://www.aneel.gov.br/aplicacoes/capacidadebrasil/operacaocapacidadebrasil.asp>

VII. BIOGRAPHIES

Hermann W. Dommel was born in Germany, where he received his engineering degrees from the Technical University of Munich. He then worked for Bonneville Power Administration in Portland, Oregon. Since 1973 he has been with the University of British Columbia in Vancouver, Canada, where he is Professor Emeritus now.

João Roberto Cogo was born in Dois Córregos, São Paulo, Brazil on August 3, 1951. He graduated from the Escola Federal de Engenharia de Itajubá (EFEI). He was titular professor at EFEL, and worked at Universidade Federal do Espírito Santo and Instituto Nacional de Telecomunicações. He now works as an engineering consultant in GSI- Engenharia e Consultoria Ltda.